

DRUSCHKE

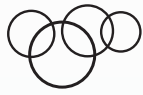

Seal manufacture

20 years of German Engineering

We offer solutions for industry and the vacuum technology sector manufactured to your particular specifications:

- ▶ Vulcanised seals (R-rings, trapezoidal ring, lip seal ring)
- ▶ O-rings
- ▶ Flat seals

in all sizes and manufactured of up to 15 different basic elastomers. Customised profiles, materials and sizes are available on request.

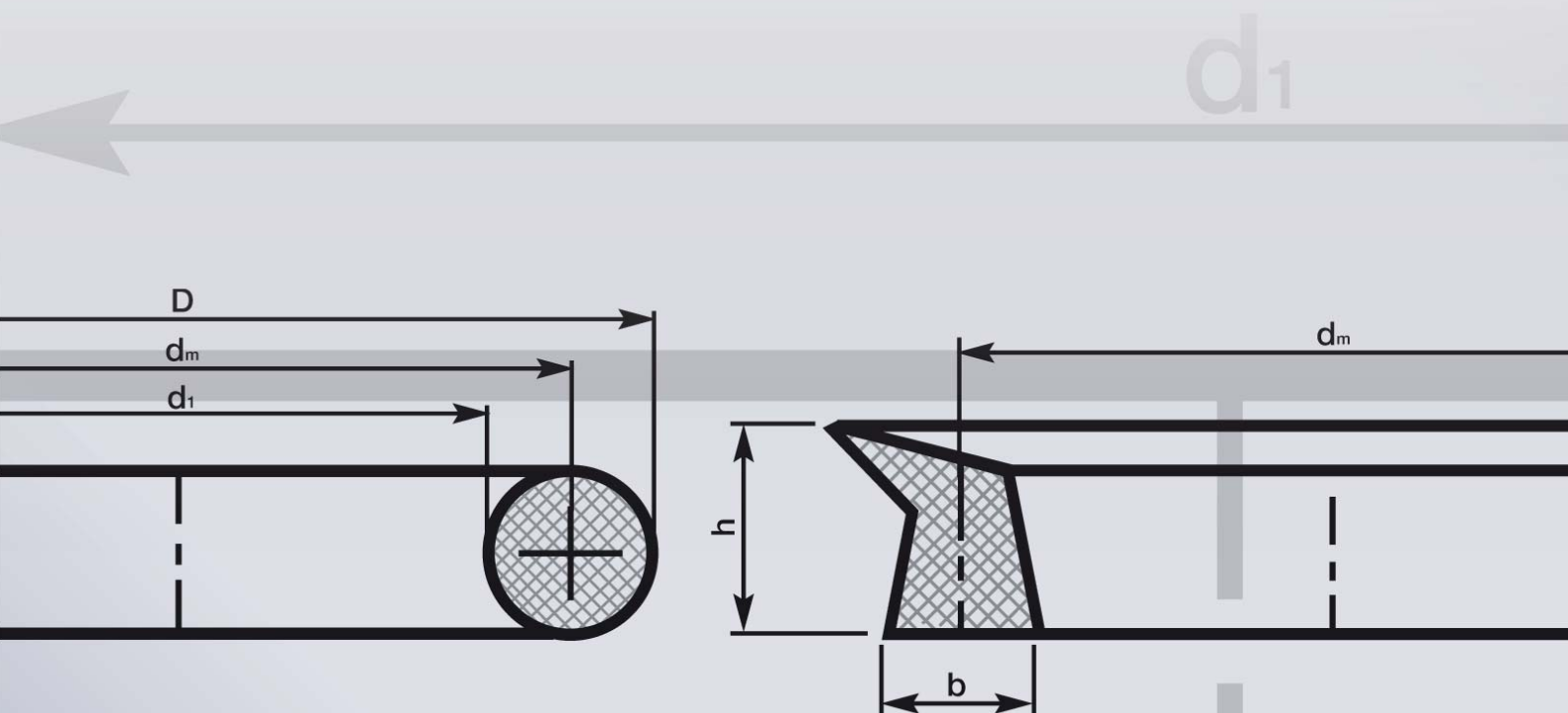

Vulcanised seals

- ▶ R-rings
- ▶ Trapezoidal rings
- ▶ Lip seals

Druschke Dichtungsfertigung (seal manufacture) has been using continuous bulk material to make ring seals for over 20 years.

Our vast experience in the use of excellent materials (superior quality = E 1), is the basis for processing bulk material to produce ring seals.

We vulcanise to the specified dimensions and/or requirements.

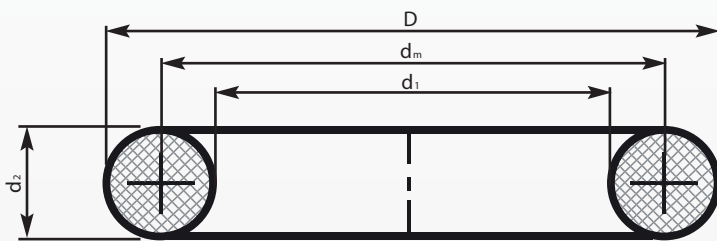

R-ring

Order sample: R-ring 100 x 6
 Equal to: $d_1 = 100\text{mm}$, $d_2 = 6\text{mm}$
 $L = (\text{stretched length}) = d_m \times 3,14$
 $L = 106 \times 3,14 = 333$

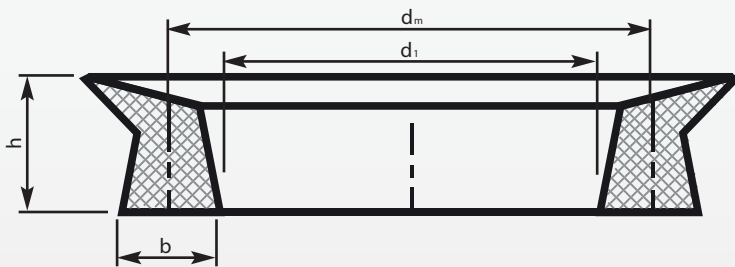

Lip seal ring

Order sample:
 Lip seal ring 10 x 15 x 3000
 Equal to: $b = 10\text{mm}$, $h = 15\text{mm}$, $d_1 = 3000\text{mm}$
 $L = (\text{stretched length}) = d_m \times 3,14$
 $L = 3010 \times 3,14 = 9451$

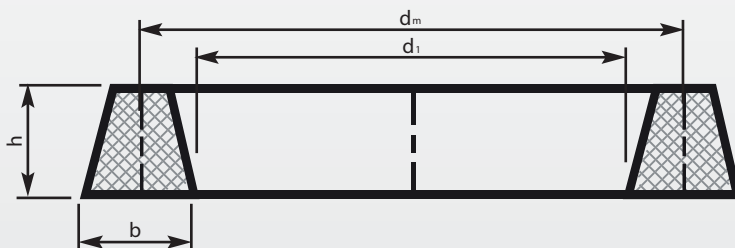

Trapezoidal ring

Order sample: Trapezoidal ring 10 x 15 x 3000
 Equal to: $b = 10\text{mm}$, $h = 15\text{mm}$, $d_1 = 3000\text{mm}$
 $L = (\text{stretched length}) = d_m \times 3,14$
 $L = 3010 \times 3,14 = 9451$

Key: d_1 = inside diameter d_m = mean diameter
 d_2 = seal thickness D = outside diameter

L = stretched length
 h = seal height

DRUSCHKE

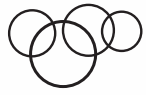

Seal manufacture

O-rings

O-rings are a major, indispensable component for industry and trade!

Superior quality, service, reliability and know-how are our trademarks!

We have been working with leading German elastomer manufacturers for over 20 years.

Our working relationships are driven by the challenge of meeting our high quality and precision expectations at all times. Continuous quality controls ensure that these expectations are fulfilled.

An independent O-ring distributor, our company is today an established supplier across many sectors.

We are a leading supplier in the elastomer sector for vacuum applications.

You can purchase O-rings from us in approx. 50,000 different dimensions and a wide range of materials – we will deliver within 24 hours in most cases!

Our product portfolio:

- ▶ Standard O-rings to ISO 3601 and elastomer seals in all current materials: AU, CSM, CR, EPDM, EPM, FEPM, FFKM, FKM / FPM, FVMQ, HNBR, IIR, NBR, NR, PTFE, VMQ
- ▶ Inside diameters from 0.74mm to 1,400mm, cord thicknesses from 0.6mm to 30mm
- ▶ Express manufacturing within seven business days is also available for small batches
- ▶ Express deliveries worldwide
- ▶ Access to the largest European warehouse thanks to reliable partner network (overnight deliveries available)



Karl Druschke Dichtungsfertigung

Am Bruchweg 2
63571 Gelnhausen / Meerholz

Phone: +49 (0)6051 / 916678 - 0
Fax: +49 (0)6051 / 916678 - 17

E-mail: dichtungsfertigung@druschke.eu
Web: www.druschke.eu

Flat seals

Thanks to a new machine pool and state-of-the-art punch and plotter technology, we are capable of producing small batch series or custom flat seals to match samples or drawings supplied up to a size of 600x1000 mm within 24 hours.

We can of course, also produce large seal batches quickly and in perfect quality.

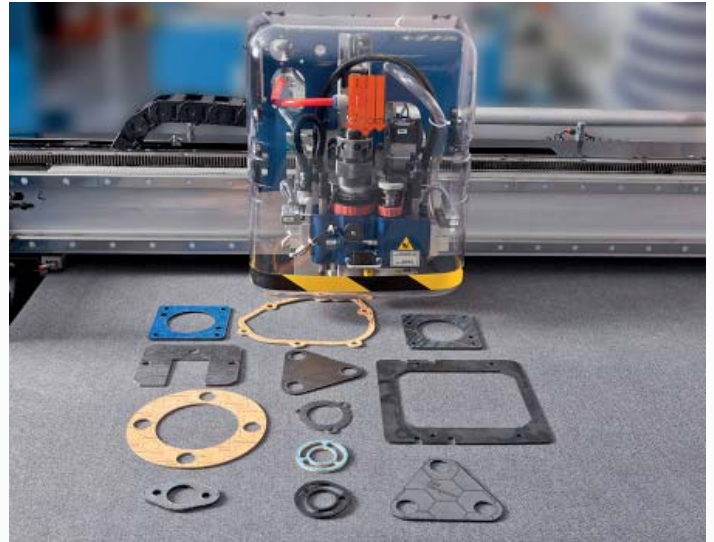

Flat seals can be made from the following materials:

- Fibrous materials:** KLINGERSIL® mineral fibre (composite materials), aramid fibre (composite materials), carbon fibre (composite materials)
- Elastomer materials:** NBR, FPM (FKM, Viton), silikon (MVQ), EPDM
- Plastics:** PTFE, PE
- Natural products:** Cork, rubber-cork

Manufacturing sample:

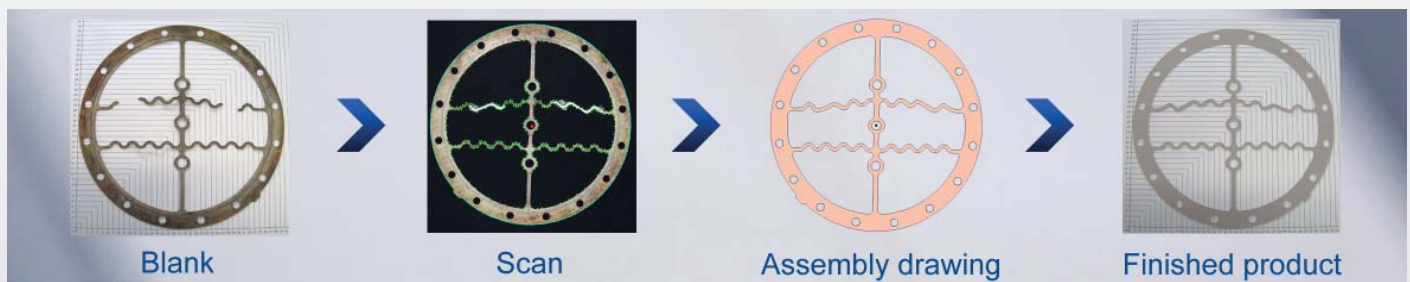

Karl Druschke Dichtungsfertigung